

1743793-1 ✓ ACTIVE

AMP | AMP MCP 9.5, AMP MCP Connector System

TE Internal #: 1743793-1

Housing for Female Terminals, Wire-to-Wire, 1 Position, Sealable, Black, Power, Cable Mount (Free-Hanging), Hybrid

[View on TE.com >](#)



Connectors > Automotive Connectors > Automotive Housings > AMP MCP Unsealed Connector Housings



Connector System: **Wire-to-Wire**

Number of Positions: 1

Connector & Housing Type: **Housing for Female Terminals**

Sealable: **Yes**

Mating Tab Width: 9.5 mm [.374 in]

[All AMP MCP Unsealed Connector Housings \(187\)](#)

Features

Product Type Features

Mixed & Hybrid Connector	No
Connector Shape	Circular
Connector System	Wire-to-Wire
Connector & Housing Type	Housing for Female Terminals
Sealable	Yes
Primary Locking Feature	On the Terminal

Configuration Features

Number of Positions	1
Number of Rows	1

Body Features

Cable Exit Angle	180°
Primary Product Color	Black

Contact Features



Contact Size	9.5mm
Contact Type	Receptacle
Mating Tab Width	9.5 mm[.374 in]

Mechanical Attachment

Terminal Position Assurance	Yes
Mating Alignment Type	Polarization Slot
Mating Alignment	With
Connector Mounting Type	Cable Mount (Free-Hanging)

Housing Features

Housing Material	PA GF
------------------	-------

Dimensions

Connector Height	34.2 mm[1.346 in]
Product Width	59 mm[2.322 in]
Product Length	34 mm[1.378 in]

Operation/Application

Circuit Application	Power
---------------------	-------

Other

Serviceable	Yes
Connector Position Assurance Capable	No

Product Compliance

[For compliance documentation, visit the product page on TE.com>](#)

EU RoHS Directive 2011/65/EU	Compliant
EU ELV Directive 2000/53/EC	Compliant
China RoHS 2 Directive MIIT Order No 32, 2016	No Restricted Materials Above Threshold
EU REACH Regulation (EC) No. 1907/2006	Current ECHA Candidate List: JUNE 2023 (235) Candidate List Declared Against: JAN 2023 (233) Does not contain REACH SVHC
Halogen Content	BFR/CFR/PVC Free, but Br/Cl >900 ppm in other sources.
Solder Process Capability	Not applicable for solder process capability

Product Compliance Disclaimer

This information is provided based on reasonable inquiry of our suppliers and represents our current actual knowledge based on the information they provided. This information is subject to change. The part numbers that TE has identified as EU RoHS compliant have a maximum concentration of 0.1% by weight in homogenous materials for lead, hexavalent chromium, mercury, PBB, PBDE, DBP, BBP, DEHP, DIBP, and 0.01% for cadmium, or qualify for an exemption to these limits as defined in the Annexes of Directive 2011/65/EU (RoHS2). Finished electrical and electronic equipment products will be CE marked as required by Directive 2011/65/EU. Components may not be CE marked. Additionally, the part numbers that TE has identified as EU ELV compliant have a maximum concentration of 0.1% by weight in homogenous materials for lead, hexavalent chromium, and mercury, and 0.01% for cadmium, or qualify for an exemption to these limits as defined in the Annexes of Directive 2000/53/EC (ELV). Regarding the REACH Regulation, the information TE provides on SVHC in articles for this part number is based on the latest European Chemicals Agency (ECHA) 'Guidance on requirements for substances in articles' posted at this URL: <https://echa.europa.eu/guidance-documents/guidance-on-reach>

Compatible Parts

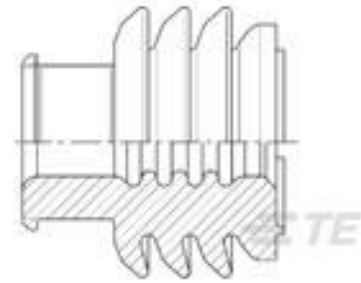

TE Part # 1355437-2
MCP9,5 EINZELDICHTEG



TE Part # CAT-AM705-T273
AMP MCP, RECEPTACLE AND TAB



TE Part # 1743797-1
MCP 9.5MM 1P CAP ASSY

Also in the Series | AMP MCP 9.5



Automotive Housings(17)



Automotive Terminals(2)



Connector Seals & Cavity Plugs(3)

Also in the Series | AMP MCP Connector System



Automotive Connector Caps & Covers (23)

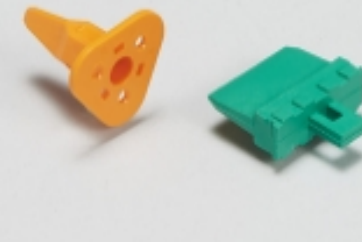

Automotive Connector Locks & Position Assurance(6)



Automotive Housings(332)



Automotive Terminals(130)

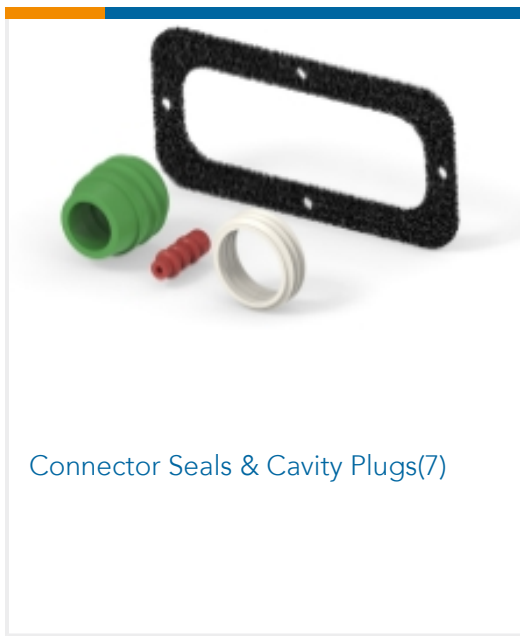

Connector Seals & Cavity Plugs(7)

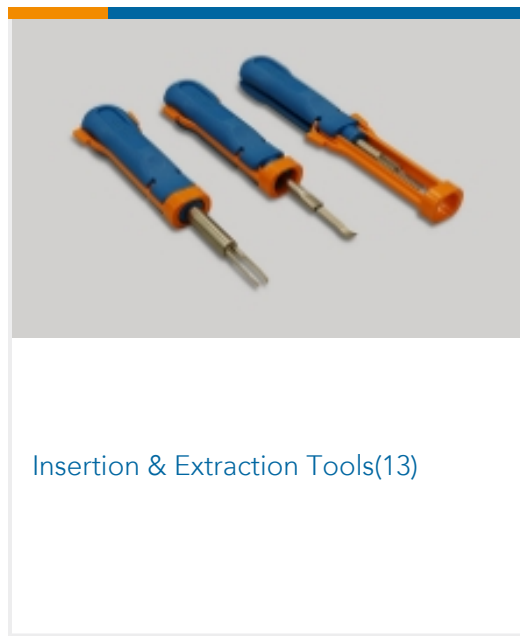

Insertion & Extraction Tools(13)

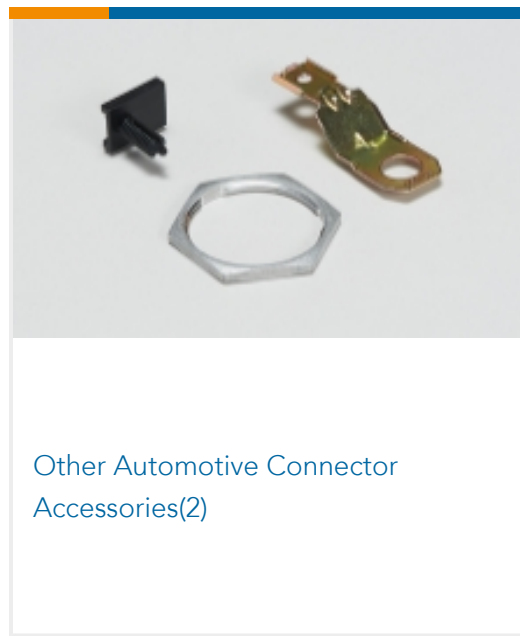

Other Automotive Connector Accessories(2)



PCB Headers & Receptacles(28)

Customers Also Bought



TE Part #1-1318853-3
025 24POS CAP ASSY H SELECTIVE-TIN



TE Part #2050898-3
CMC 112WAY HEADER ASSEMBLY



TE Part #2301335-2
94POS, HYBRID, HDR ASSY, 90DEG



TE Part #2379006-1
52POS, HYBRID, REC HSG ASSY



TE Part #474108-E
SRCA 1,27 2 M 1-KS SMD 137 E1 094 * GURT



TE Part #474356-E
SMCQ 50 M AB VV 8-13 CL * H007 137 E005



TE Part #474812-E
SRCA 1,27 10 M 1-KS SMD 137 E1 094 * GURT

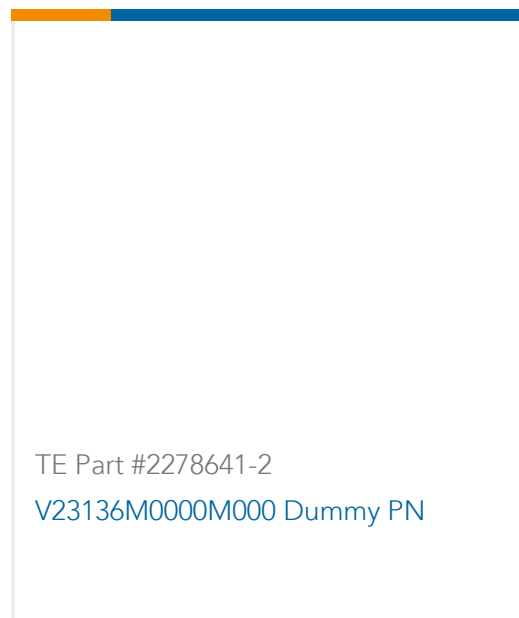

TE Part #2278641-2
V23136M0000M000 Dummy PN

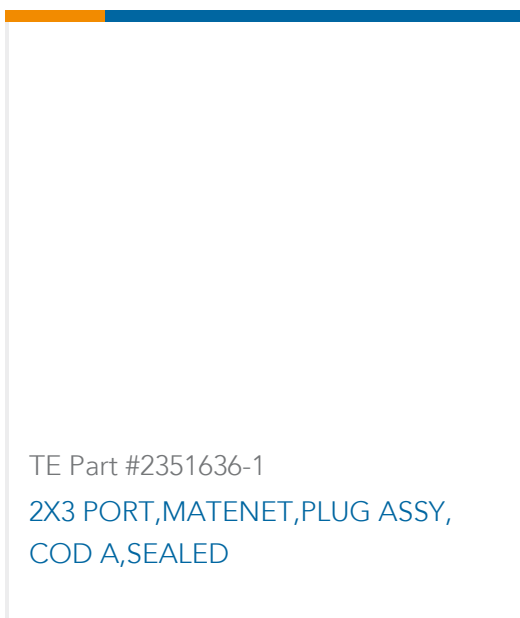

TE Part #2351636-1
2X3 PORT, MATENET, PLUG ASSY, COD A, SEALED

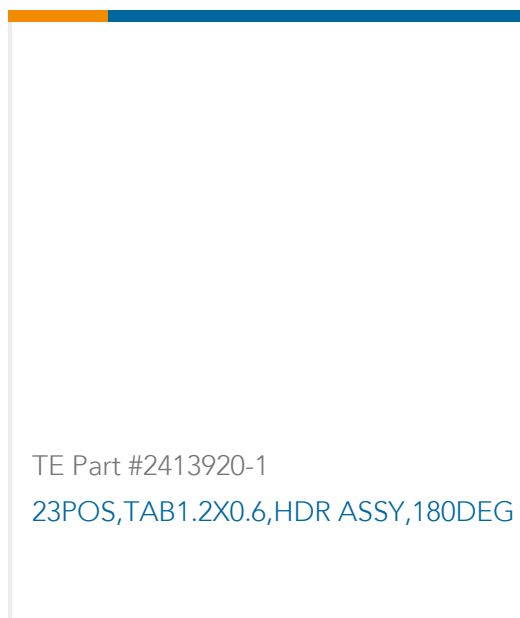

TE Part #2413920-1
23POS, TAB1.2X0.6, HDR ASSY, 180DEG

Documents

Product Drawings

MCP 9.5MM 1P PLUG ASSY

English

CAD Files

3D PDF

3D

Customer View Model

ENG_CVM_CVM_1743793-1_A1.2d_dxf.zip



English

Customer View Model

[ENG_CVM_CVM_1743793-1_A1.3d_igs.zip](#)

English

Customer View Model

[ENG_CVM_CVM_1743793-1_A1.3d_stp.zip](#)

English

By downloading the CAD file I accept and agree to the [Terms and Conditions](#) of use.

Product Specifications

[Product Specification](#)

English

Instruction Sheets

[Instruction Sheet \(non U.S.\)](#)

English